



ADSP-IV SERIES

Owner's Manual

Before operating the unit, please read this manual thoroughly and retain it for future reference.
Any updates are available on zapco.com/download

Table of Contents

General instructions	4
IT <i>Istruzioni Generali</i>	
DE <i>Allgemeine Anweisungen</i>	
FR <i>Instructions Générales</i>	
ES <i>Instrucciones Generales</i>	
CH <i>常规安装指引</i>	
The new Zapco ADSP-IV Series	7
DSP/Amp Panels	8
Remote Control	12
The Microphone	13
The Graphical User Interface	14
The Main Screen	14
The Advanced Menu	17
The File Menu	20
Manual Setup without Auto Calibration	21
Manual Tuning	23
Technical Specifications	29

EN General Instructions

The installation of the product must be done by professional technicians. Always contact a ZAPCO Authorized Dealer.

Before you start your installation

ZAPCO highly recommends that a fuse or circuit breaker be placed within 18" of the battery. The protection device should be placed where it can be accessed easily and all wiring should be routed safely and correctly according to the following guidelines:

- Do not run wiring close to hot or spinning objects
- Always use wire grommets when routing wire through the firewall or any other metal panels
- Make sure that the potential for pinched wiring is avoided by routing all wires away from moving objects, including brake, gas and clutch pedals, etc.

Planning your power connections

- The +12V B is the main power input. This must be connected to the vehicle battery's positive (+) terminal
- The GND is the main ground or negative connection. This must be securely attached to bare metal at the vehicle frame
- The terminal between the main power and ground is the +12 turn-on input (REM) and can be connected to the head unit turn-on output wire. If none is available it can be connected to an accessory (ACC) terminal

Mounting your amplifier

Mounting your Zapco amplifier is easy. Just keep in mind a few guidelines:

- The amplifier requires adequate ventilation. Creating power creates heat, and cooling requires air
- Keep the amplifier out of the engine compartment or other locations that may cause excessive heat or moisture
- Do not mount the amplifier to a subwoofer box or other place that may have excessive vibration

Setting Gains

Gain pots are not volume controls and should be used only if absolutely necessary. Turning up gain controls causes increased noise, makes distortion more likely and reduces the dynamic range of your system.

Continuous exposure to excessive sound pressure levels may cause hearing damage. ZAPCO strongly advises that you use common sense when setting volume levels. Everything written in this manual is for the proper use of the products. Some features or specifications could be modified during production to improve the product performance. The technical specifications and functionalities stated here are current as of the time of publication.

IT Istruzioni Generali

L'installazione del prodotto deve essere effettuata da tecnici professionisti. Rivolgersi ad un Rivenditore Autorizzato ZAPCO.

Prima di iniziare l'installazione

ZAPCO consiglia vivamente di posizionare un fusibile entro 18" dalla batteria. Il dispositivo di protezione deve essere posizionato in un punto di facile accesso e tutti i cablaggi devono essere instradati in modo sicuro e corretto secondo le seguenti linee guida:

- Non eseguire il cablaggio vicino ad oggetti caldi o taglienti
- Utilizzare sempre i passacavi quando si instrada il cavo attraverso pannelli metallici
- Assicurarsi che venga evitato il rischio di schiacciamento dei cavi allontanando tutti i cavi da oggetti in movimento, inclusi i pedali del freno, dell'acceleratore e della frizione

Pianificare l'alimentazione

- Il +12V B è l'ingresso di alimentazione principale. Questo deve essere collegato al terminale positivo (+) della batteria dell'auto
- Il GND è la massa principale o il collegamento negativo. Questo deve essere fissato saldamente al metallo del telaio del veicolo
- Il terminale tra l'alimentazione principale e la massa è l'ingresso di accensione +12 (REM) e può essere collegato al cavo di uscita di accensione dell'unità principale. Se non è disponibile, può essere collegato ad un terminale accessorio (ACC)

Installare l'amplificatore

Installare il tuo amplificatore Zapco è facile. Basta tenere a mente alcune linee guida:

- L'amplificatore richiede una ventilazione adeguata. Creare potenza crea calore ed il raffreddamento richiede aria
- Tenere l'amplificatore fuori dal vano motore o altri luoghi che potrebbero causare calore o umidità eccessivi
- Non installare l'amplificatore su un subwoofer o in un altro posto che potrebbe generare vibrazioni eccessive

Regolazione guadagni

I potenziometri di guadagno non sono controlli del volume dovrebbero essere usati solo se assolutamente necessario. Aumentare il guadagno provoca un aumento del rumore, distorsione e riduce la gamma dinamica.

L'esposizione continua a livelli di pressione sonora eccessivi può causare danni all'udito. ZAPCO consiglia vivamente di utilizzare il buon senso quando si impostano i livelli di volume. Tutto quanto scritto in questo manuale è finalizzato al corretto utilizzo dei prodotti. Alcune caratteristiche o specifiche possono essere modificate durante la produzione per migliorare il prodotto. Le specifiche tecniche e le funzionalità qui riportate sono aggiornate al momento della pubblicazione.

DE Allgemeine Anweisungen

Die Produktinstallation sollte von professionellen Technikern durchgeführt werden. Wenden Sie sich immer an einen Autorisierten ZAPCO-Händler.

Bevor Sie mit der Installation beginnen

ZAPCO empfiehlt dringend, eine Sicherung innerhalb von 18 Zoll von der Batterie zu platzieren. Der Schutz muss an einer leicht zugänglichen Stelle angebracht werden und die gesamte Verkabelung muss gemäß den folgenden Richtlinien sicher und korrekt verlegt werden:

- Verkabeln Sie das Gerät nicht in der Nähe von heißen oder scharfen Gegenständen
- Bei der Kabeldurchführung immer Kabelverschraubungen verwenden Metallplatten
- Stellen Sie sicher, dass die Gefahr eines Einklemmens des Kabels vermieden wird, indem Sie alle Kabel von sich bewegenden Objekten fernhalten, einschließlich Brems-, Gas- und Kupplungspedale usw

Planen Sie die Stromversorgung

- +12V B ist der Hauptstromeingang. Dieser muss an den Pluspol (+) der Autobatterie angeschlossen werden
- Der GND ist die Hauptmasse oder negative Verbindung. Dieser muss sicher am Metall des Fahrzeugchassis befestigt sein
- Der Anschluss zwischen Hauptstrom und Masse ist der Zündeingang +12 (REM) und kann an die Zündausgangsleitung des Hauptgeräts angeschlossen werden. Wenn es nicht verfügbar ist, kann es an ein Zubehörterminal (ACC) angeschlossen werden

Installieren Sie den Verstärker

Die Einrichtung Ihres Zapco-Verstärkers ist einfach. Beachten Sie einfach ein paar Richtlinien:

- Der Verstärker benötigt eine ausreichende Belüftung. Bei der Stromerzeugung entsteht Wärme, für die Kühlung ist Luft erforderlich
- Bewahren Sie den Verstärker außerhalb des Motorraums oder anderer Orte auf, an denen übermäßige Hitze oder Feuchtigkeit entstehen könnte
- Installieren Sie den Verstärker nicht auf einem Subwoofer oder an einem anderen Ort, der übermäßige Vibrationen erzeugen könnte

Verstärkungsanpassung

Gain-Potentiometer sind keine Lautstärkereger, sie sollten es sein nur dann verwendet werden, wenn dies unbedingt erforderlich ist. Eine Erhöhung der Verstärkung führt zu mehr Rauschen und Verzerrungen und verringert den Dynamikbereich.

Ständige Einwirkung übermäßiger Schalldruckpegel kann zu Gehörschäden führen. ZAPCO empfiehlt dringend, beim Einstellen der Lautstärke den gesunden Menschenverstand zu nutzen. Alles, was in diesem Handbuch geschrieben wird, zielt auf die korrekte Verwendung der Produkte ab. Einige Funktionen oder Spezifikationen können während der Produktion geändert werden, um das Produkt zu verbessern. Die hier gezeigten technischen Spezifikationen und Funktionen sind zum Zeitpunkt der Veröffentlichung aktuell.

FR Instructions Générales

L'installation du produit doit être effectuée par des techniciens professionnels. Contactez toujours un Revendeur agréé ZAPCO.

Avant de commencer votre installation

ZAPCO recommande fortement qu'un fusible ou un disjoncteur soit placé à moins de 18 pouces (moins de 45 centimètres) de la batterie. Le dispositif de protection doit être placé là où il est facilement accessible et tout le câblage doit être acheminé en toute sécurité et correctement selon les directives suivantes:

- Ne faites pas passer le câblage à proximité d'objets chauds ou en rotation
- Utilisez toujours des passe-fils lorsque vous faites passer le fil à travers le pare-feu ou tout autre panneau métallique
- Assurez-vous que tout risque de pincement des câbles soit évité en acheminant tous les fils loin des objets en mouvement, y compris les pédales de frein, d'accélérateur, d'embrayage, etc.

Planification de vos connexions électriques

- Le +12V B est l'entrée d'alimentation principale. Celui-ci doit être connecté à la borne positive (+) de la batterie du véhicule
- Le GND est la masse principale ou connexion négative. Celui-ci doit être solidement fixé au métal nu sur le châssis du véhicule
- La borne entre l'alimentation principale (+12V B) et la masse (GND) est l'entrée de mise sous tension +12 (REM) et peut être connectée au fil de sortie de mise sous tension de l'unité principale. Si aucun n'est disponible, il peut être connecté à une borne accessoire (ACC). Vous devez éviter d'utiliser des fils d'allumage (IGN), car ils peuvent être bruyants

Montage de votre amplificateur

Le montage de votre amplificateur Zapco est facile. Gardez simplement à l'esprit quelques directives:

- L'amplificateur nécessite une ventilation adéquate. La création d'énergie crée de la chaleur et pour le refroidissement on nécessite de l'air
- Gardez l'amplificateur hors du compartiment moteur ou de tout autre endroit susceptible de provoquer une chaleur ou une humidité excessive
- Ne montez pas l'amplificateur sur un caisson de basses ou dans tout autre endroit susceptible de générer des vibrations excessives

Définition des gains

Les potentiomètres de gain ne sont pas des commandes de volume. Augmenter les commandes de gain entraîne une augmentation du bruit, rend la distorsion plus probable et réduit la plage dynamique de votre système.

Une exposition continue à des niveaux de pression sonore excessifs peut provoquer des lésions auditives. ZAPCO vous conseille fortement de faire preuve de bon sens lors du réglage des niveaux de volume. Tout ce qui est écrit dans ce manuel est destiné à la bonne utilisation des produits. Certaines caractéristiques ou spécifications pourraient être modifiées en cours de production pour améliorer les performances du produit. Les spécifications techniques et les fonctionnalités indiquées ici sont à jour au moment de la publication.

ES Instrucciones Generales

La instalación del producto debe ser realizada por técnicos profesionales. Comuníquese siempre con un Distribuidor Autorizado ZAPCO.

Antes de comenzar su instalación

ZAPCO recomienda encarecidamente colocar un fusible o disyuntor a 18 pulgadas (menos de 45 cm) de la batería. El dispositivo de protección debe colocarse en un lugar de fácil acceso y todo el cableado debe tenderse de forma segura y correcta de acuerdo con las siguientes pautas:

- No tienda cables cerca de objetos calientes o giratorios
- Utilice siempre pasacables cuando pase el cable a través del cortafuegos o cualquier otro panel metálico
- Asegúrese de evitar la posibilidad de que los cables queden atrapados colocando todos los cables lejos de objetos en movimiento, incluidos los pedales de freno, acelerador, embrague, etc.

Plificación de sus conexiones eléctricas

- El +12V B es la entrada de alimentación principal. Este debe conectarse al terminal positivo (+) de la batería del vehículo
- El GND es la conexión a tierra principal o negativa. Este debe estar firmemente sujeto al metal desnudo en el marco del vehículo
- El terminal entre la alimentación principal (+12V B) y tierra (GND) es la entrada de encendido +12 (REM) y se puede conectar al cable de salida de encendido de la unidad principal. Si no hay ninguno disponible, se puede conectar a un terminal accesorio (ACC). Debes evitar el uso de cualquier cable de encendido (IGN), ya que pueden ser ruidosos

Montaje de su amplificador

Montar su amplificador Zapco es fácil. Solo tenga en cuenta algunas pautas:

- El amplificador requiere una ventilación adecuada. La creación de energía genera calor y la para la refrigeración se requiere aire
- Mantenga el amplificador fuera del compartimiento del motor u otros lugares que puedan causar calor o humedad excesivos
- No monte el amplificador sobre una caja de subwoofer u otro lugar que pueda tener vibraciones excesivas

Configuración de ganancias

Los potenciómetros de ganancia no son controles de volumen. Antes de encender su sistema por primera vez, debe asegurarse de que todos los controles de ganancia estén configurados al mínimo. Los controles de ganancia deben usarse sólo si es absolutamente necesario. Subir los controles de ganancia provoca un aumento del ruido, aumenta la probabilidad de distorsión y reduce el rango dinámico de su sistema. Si su unidad principal no tiene suficiente salida, obtendrá resultados mucho mejores si invierte en un amplificador de línea para proporcionar más señal al amplificador.

La exposición continua a niveles excesivos de presión sonora puede causar daños auditivos. ZAPCO recomienda que utilice el sentido común al configurar los niveles de volumen. Todo lo escrito en este manual es para el uso adecuado de los productos. Algunas características o especificaciones podrían modificarse durante la producción para mejorar el rendimiento del producto. Las especificaciones técnicas y las funcionalidades aquí indicadas están actualizadas en el momento de la publicación.

CH 常规安装指引

产品的安装必须由熟练的技术人员完成。请始终联系 ZAPCO 授权经销商。

开始安装前

ZAPCO 强烈建议在电池附近的 18 英寸 (约 45.7 厘米) 内放置一个保险丝或断路器。保护装置应放置在易于触及的位置。所有布线应根据以下准则安全正确地布置:

- 不要将电线靠近热源或旋转物体
- 在将电线引导穿越防火墙或任何其他金属面板时, 务必使用电线防护套
- 确保所有电线远离汽车可以移动的部件, 包括刹车、油门和离合踏板等, 以避免电线被夹

电源连接的准备工作

- +12V B 是主要的电源输入, 必须连接到车辆电池的正极 (+) 端
- GND 是主要的接地或负极连接, 必须牢固地连接到车辆车架上的裸露金属部位
- 主电源和地之间的端子是 +12 转换输入 (REM), 可以连接到主机的 开关输出线, 如果没有可用的线, 它可以连接到附件 (ACC) 终端。应避免使用任何点火 (IGN) 线, 因为这可能会产生噪音

安装功放机

安装 ZAPCO 功放机非常简单, 只需记住一些准则:

- 功放机需要足够的通风。因为产生功率会产生热量, 冷却需要空气
- 不要将功放机安装在发动机舱或可能产生过多热量或湿气的地方
- 不要将功放机安装在低音炮音箱或其他可能有过多振动的地方

设置增益

增益旋钮不是音量控制。在首次启动系统之前, 应确保所有增益控制设置为最小值。增益控制只应在绝对必要的情况下使用。增大增益控制会导致噪音增加, 增加失真可能性, 并降低系统的动态范围。如果您的主机输出不足, 最好购买信号放大器以向功放机提供更多信号, 从而获得更好的音效。

长时间暴露于过高的声压级可能会导致听力损伤。ZAPCO 强烈建议在设置音量水平时要注意保护听力。本手册中的所有内容都是为了正确使用产品而编写的。一些功能或规格可能会在生产过程中进行修改以提高产品性能。此处陈述的技术规格和功能只针对本手册出版日期前的功放机产品

The new Zapco ADSP-IV Series

Congratulations on your purchase of this new Zapco product. It has been designed and built to give you many years of reliable, industry leading performance and true audiophile level sound quality.

Zapco introduced the world to full function in-car digital processing in 2004 with the Zapco DSP-6 and the Zapco Digital Processing Network. This was the first full function DSP for the car and included a full line of amplifiers with full function digital processing build right in. In 2016 we brought out our fourth generation of processing in the Zapco DSP-Z8 IV. The Z8 IV was a mid-priced unit designed to bring audiophile processing in an affordable package, and it did just that. The Zapco DSP-Z8IV met rave reviews, out performing DSPs costing twice as much, with a straightforward, easy to navigate interface so tuning would be a breeze, and an analog signal to noise of -106dB (-110dB Digital).

The new DSP-Z8 IV AT series processing takes the IV to a whole new level of performance and convenience. Sonically, the DSP-Z8 IV AT has all the qualities of the original IV with an even lower noise floor, upgrades to the PC interface to help in system setup and offer more system design possibilities, even automatic calibration (Autotune, available only for DSP-Z8 IV AT and ADSP-Z8 IV-6AT units) for Equalization, Signal Delay, and Phase, so your first tune can take minutes instead of hours... or even days. Just a click on the PC interface and the system tunes itself. All you'll need is the optional calibration microphone.

The new coaxial and optical inputs accept the digital signal from your head unit or from a portable HD player. The DSP-IV units also have a port for HD Bluetooth streaming (with the optional HD-BT module). An interactive digital port will expand your options even more. The port accepts the control input from the included Dash Remote so you can change input source, select your song, control the master volume and even control the output of your system's bass amps. The new ADSP-Z8 IV-6AT amplifier has 6 amplified channels, while the ADSP-Z12IV 10-A (with 12-ch. DSP) has 12 amplified channels and the ADSP-Z16IV 12-A (with 16-ch. DSP) has 12 amplified channels.

Reality Check

The automobile is a difficult environment for listening to music. There are reflective surfaces that distort the sound, absorptive surfaces that impede it, and you are never in the ideal listening position. The DSP-IV AT automatic calibration will compensate for the shortfalls of the auto environment to help create the live listening experience. However, the human ear is still the final word for sound.

DSP-Z8 IV AT Panels

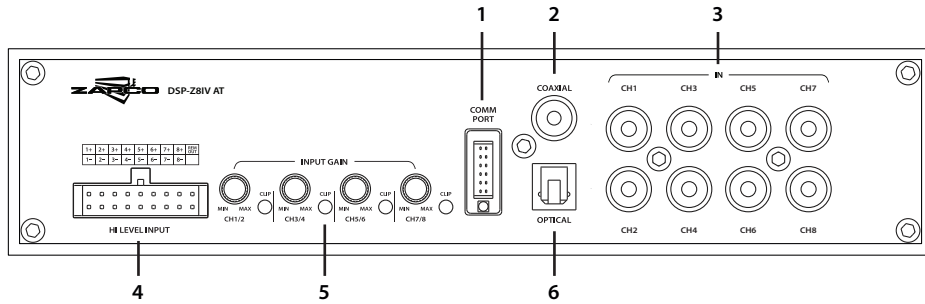

- 1. Comm Port for HD-BT module
- 2. Coaxial digital input
- 3. 8-Channel RCA inputs
- 4. Speaker level input plug for OEM hookup
- 5. Variable gain controls with clip indicators
- 6. Optical digital input
- 7. 8-Channel RCA outputs
- 8. Microphone Input for Auto-Tuning
- 9. Dash remote port
- 10. USB LED
- 11. USB connector for PC control
- 12. Power-On LED
- 13. Power/Rem/Gnd connector
- 14. Auto-on switch for OEM integration

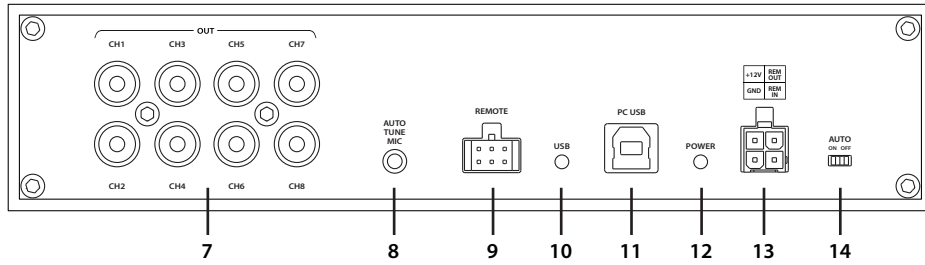

ADSP-Z8 IV-6AT Panels

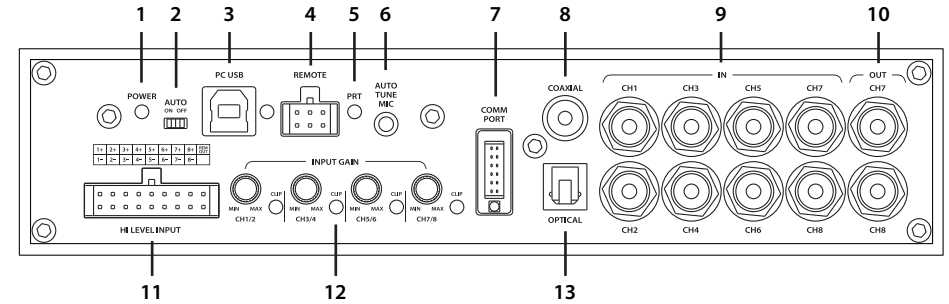

- 1. Power-On LED
- 2. Auto-on switch for OEM integration
- 3. USB connector for PC control
- 4. Dash remote port
- 5. Protection LED
- 6. Microphone Input for Auto-Tuning
- 7. Comm Port for HD-BT module
- 8. Coaxial digital input
- 9. 8-Channel RCA inputs
- 10. 2-Channel RCA outputs
- 11. Speaker level input plug for OEM hookup
- 12. Variable gain controls with clip indicators
- 13. Optical digital input
- 14. Speaker output connectors for Ch 1~2
- 15. Speaker output connectors for Ch 3~4
- 16. Speaker output connectors for Ch 5~6
- 17. Power/Rem/Gnd terminals

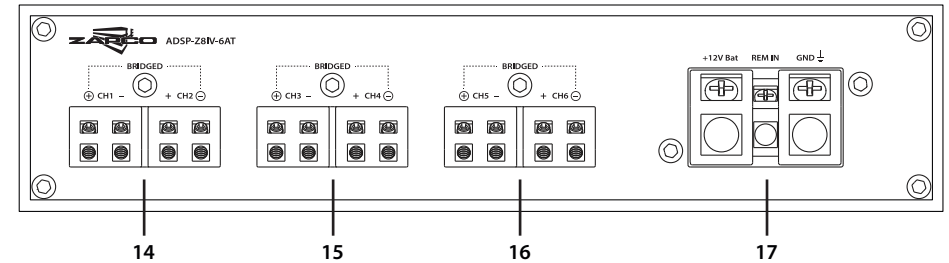

Note: The left channel positive terminal and the right channel negative terminal are used for bridging the speaker outputs. The amp is stable at 2 ohms stereo or 4 ohms mono. The amp should not be run at 2 ohms mono

ADSP-Z12 IV-10A Panels

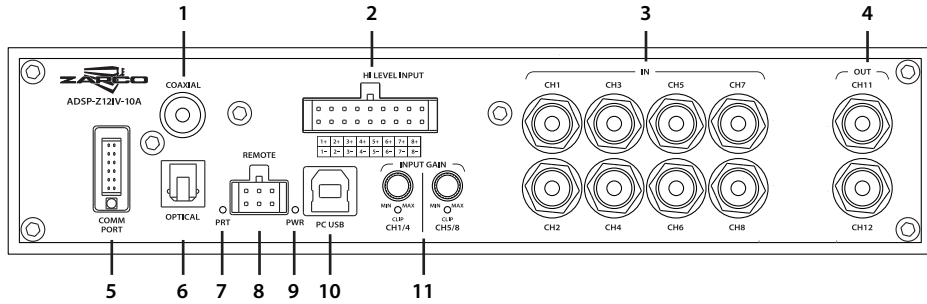

- 1. Coaxial digital input
- 2. Speaker level input plug for OEM hookup
- 3. 8-Channel RCA inputs
- 4. 2-Channel RCA outputs
- 5. Comm Port for HD-BT module
- 6. Optical digital input
- 7. Protection LED
- 8. Dash remote port
- 9. Power LED
- 10. USB connector for PC control
- 11. Variable gain controls with clip indicators
- 12. Speaker output connectors for Ch 1, 2, 3, 4, 5, 7
- 13. Speaker output connectors for Ch 6, 8, 9, 10
- 14. Remote Out
- 15. Auto Turn-On
- 16. Power/Rem/Gnd terminals

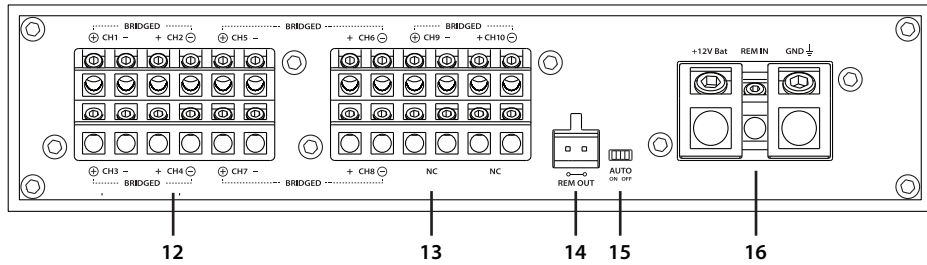

ADSP-Z16 IV-12A Panels

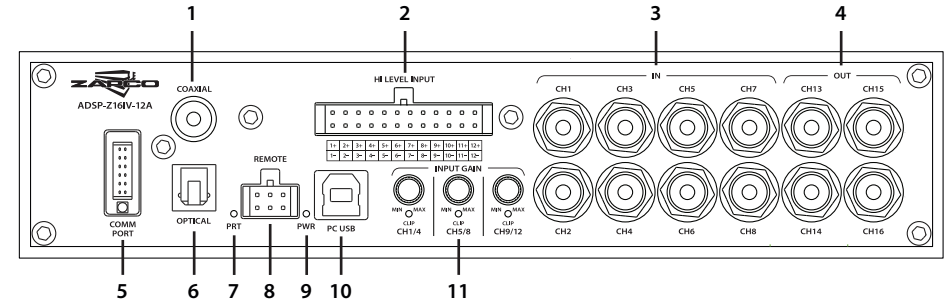

- 1. Coaxial digital input
- 2. Speaker level input plug for OEM hookup
- 3. 8-Channel RCA inputs
- 4. 4-Channel RCA outputs
- 5. Comm Port for HD-BT module
- 6. Optical digital input
- 7. Protection LED
- 8. Dash remote port
- 9. Power-On LED
- 10. USB connector for PC control
- 11. Variable gain controls with clip indicators
- 12. Speaker output connectors for Ch 1~12
- 13. Auto-on switch for OEM integration
- 14. Power/Rem/Gnd terminals

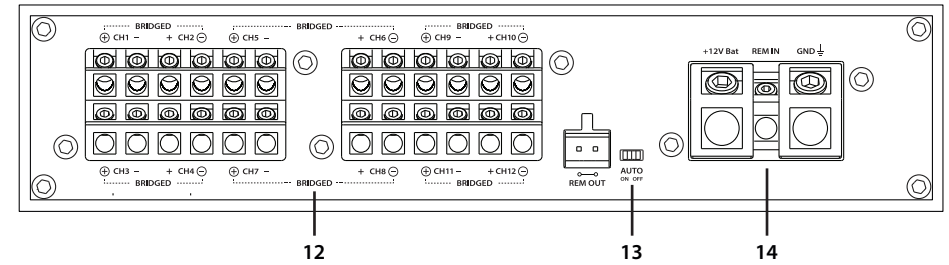

Note: The left channel positive terminal and the right channel negative terminal are used for bridging the speaker outputs. The amp is stable at 2 ohms stereo or 4 ohms mono. The amp should not be run at 2 ohms mono

Remote Control

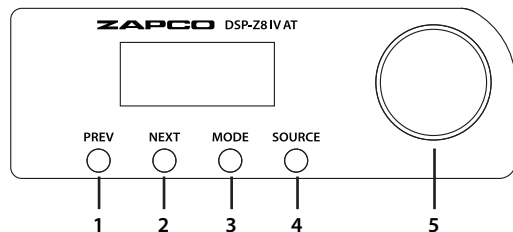

- 1.** Prev button will go to the previous saved preset (DSP)
- 2.** Next button will go to the next saved preset (DSP)
- 3.** Mode button will scroll to choose presets
- 4.** Source button

- 5.** This knob is first a volume control, which is a must when you are using a full gain digital input. Secondly, the volume control knob is also a control for the bass amp output. If you are using Channels 7/8 for the bass, you can push the volume control in for 5 seconds and it becomes a bass level control. When it has not moved for 5 sec. it reverts to a volume control. Short press the mute

The Microphone (optional for DSP-Z8 IV AT and ADSP-Z8 IV-6AT)

The M-AT1 is a special microphone for setting up the sound automatically, based on the response characteristics of the speakers and auto detail detection of the car. After detecting all the necessary information, the audio information screen will be transmitted to the computer.

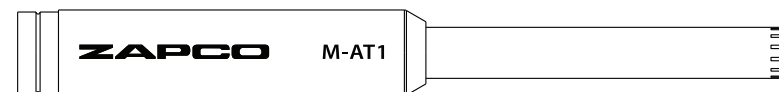

- 1.** Connect the microphone to the dedicated port of the unit
- 2.** The microphone must be fixed on the headrest of the driving position. This position is basically the same as the head of the driver

The Graphical User Interface (GUI)

The Main Screen

The Graphical Interface (GUI) for the DSP-IV AT processors requires no installation. Just download the file from the Zapco website and put it on your desktop (the number following "rc" will change from time to time as updates occur). You should check back on the site regularly to assure you have the most up-to-date version of the software. TIP: Make a folder DSP-IV AT on your desktop and put the GUI file there and you can use that folder also to save your settings to your PC as a backup in case the presets in the DSP are lost or erased by error. Below is the layout of the control program (GUI) for the DSP-IV AT processors.

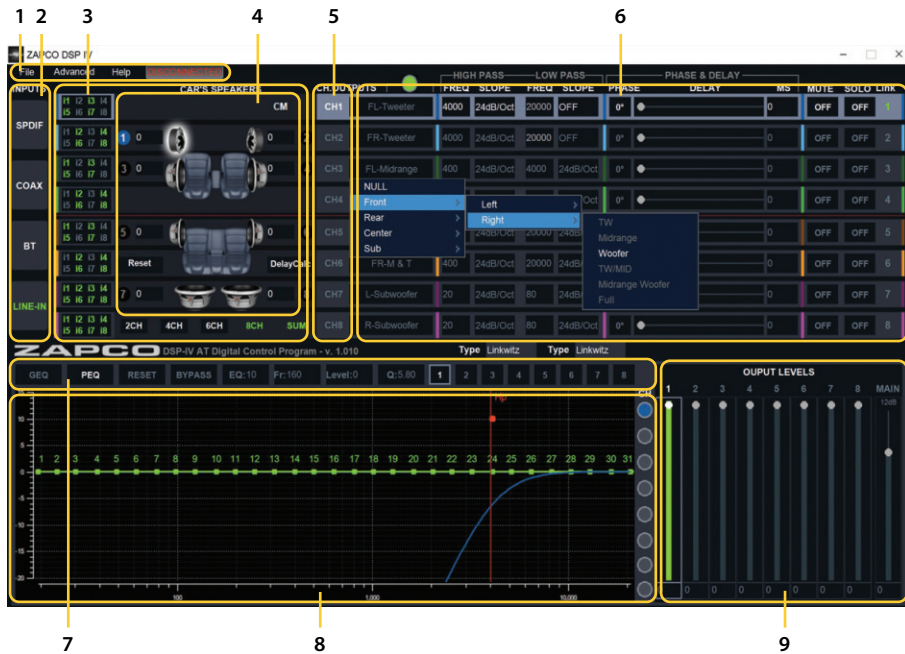

1. At the very top of the GUI there is a main menu. The **File** button with a drop-down menu is where you will save setups to memory presets and load setups from those saved. You can load and save setups in your PC (File) or in your DSP (Device) presets. See File Menu on Pag. 20. The **Advanced** menu holds the Mixing Set and the Autocalibration pages which we will look later on Pag. 17. The **Help** button is for firmware updates.

2. **Inputs:** Here you choose the input you will use while tuning. You can choose LINE IN which can be an aftermarket head unit, or a factory head unit using the speaker level input harness. You also have Optical (SPDIF) or Coax (also SPDIF) digital inputs, and a BT (Bluetooth) input if you add the optional HD-BT module for HD AptX Bluetooth streaming.

3. This section is the quick setup area and will be the go-to setup for most systems. Across the bottom you find **2CH, 4CH, 6CH, 8CH, and SUM**. All digital inputs are 2CH inputs and aftermarket head units should also be set up as 2CH inputs regardless of how many outputs the head unit has. That way all the processing can be done in the DSP. For installations using factory head units that have active crossovers you may need to use 4CH, 6CH, or even 8CH inputs to get a full range input for the processor to work with. When you do that you will want to click SUM also and then the processor will put all the left channels together and all the right channels together to give a full range signal for processing. Note that when you are summing signals, you want to use only enough of the factory speaker wires to get a full range signal.

4. **Car Diagram/Delay map:** In this section you can manually set up signal delay. Simply measure the distance from the listening position (Usually 5" to 7" ahead of the driver's headrest) to the center of each speaker and enter those distances into the speaker map in centimeters. Then click Delay Calc and the processor will calculate the correct delay for each speaker. If you have purchased the M-AT1 tuning mic for auto calibration, you can skip this process as the autotune system will set the delays for you (see Pag. 18).

5. **Ch Outputs:** This column is where you can choose the output channel you will be tuning. Clicking the channel number in this column will open the channel for tuning and will light up the channel bar to highlight the active channel.

6. **Ch Setup Area:** Contains channel designations, crossovers, delay adjustments, mute and solo buttons.

- First is the **Channel Designation** column. Above this column you will see a green or red button. When this button is red you can name each channel using the drop-down menu (i.e FL-Tweeter, or FR-Woofer, etc.). After you have named each of the drivers in your system you can change the top button to green and that will lock this column.
- Next is the **Crossover section**. There is a HP and an LP filter for each channel. You can type in the frequencies or use the up/down arrows on the keyboard. You can choose crossover style and slope or turn the crossovers off, if you do not want them for some channels. Always check the speaker makers recommendations for crossovers before you make the crossover decisions.

- c. The **Phase** column lets you adjust the polarity of each channel, so you have all speakers moving the same direction at the same time. See Pag. 22 for more information on Phase. If you have the M-AT1 calibration mic, the autotuning system will check the phase of all the speakers for you.
- d. **Delay** adjustments. During tuning, if you need to make changes in the signal delay you can do that here by typing in the numbers in the MS column, or by using the sliders. You can also link a group of channels using the vertical Link buttons in the column at the far right of this section to change the delay of a group of channels.
- e. **Mute** allows you to shut of any channels you do not want to hear when you are tuning the system.
- f. **Solo** lets you listen to only one channel by muting all channels except the chosen solo channel.
- g. **Link**: There are two link columns in this GUI. This vertical Link column operates on the Crossover, Signal Delay, and the Output Level controls to make identical changes to each of the linked channels.

7. EQ Function Bar: This row lets you choose between GEQ (Graphic) and PEQ (Parametric) equalizers. You can also Bypass the EQ temporarily to hear the sound with and without the effects of your tuning on the active channel. The Reset button resets the channel completely to return the EQ filters to flat. There are also buttons for the EQ parameters available for tuning: Band (filter) selection by number, Frequency selection, Gain, and Q Factor. You can click into these boxes to make fine adjustments as in Section 8.

8. EQ Graph: The graph shows you exactly what you are doing to the output signal going to your amps. In this graph you can Drag-and-Drop the buttons of each EQ filter to make adjustments of Frequency and Gain. Then make fine adjustments using the PC's keyboard arrows. Simply click into one of the parameter boxes for frequency, level (Gain), or Q and use the keyboard arrows. Using the right/left arrows moves between the parameters while the up/down arrows change the value of the parameters. You can also highlight the boxes and type in information. The active channel's EQ plot will always be visible, as will the crossover plot for the active channel. At the right of the graph, the color-coded buttons let you choose any other channels whose plots you want to see as well.

9. Output Levels: Output levels allow you to balance the levels of the speakers. Ideally they should all be near 0 dB. The main level control can add gain up to 12 dB for low power head units, but you reduce signal to noise ratio when you are set above 0 dB. It is far better to keep the output at 0 dB and adjust the amplifiers, to adjust for needed volume of each speaker and use the DSP level controls for the fine adjustments.

The Advanced Menu

The Advanced menu of the DSP-IV AT processor GUI, can take you to the Mixing Set where you can manually set up your inputs and outputs or to the Auto Calibration page where you can use the auto tuning functions if you have purchased the M-AT1 microphone.

With the **Mixing Set**, you can manually determine which inputs will be used for each output (processing channel) and how much of each input the output will receive.



Choosing 2Ch, 4Ch, 6Ch, etc. on the front page will set up most systems, but the Mixing Set lets the advanced user get exactly what he needs for the more complicated setups. The inputs are listed down the left side and the output channels are listed across the bottom. Example: You can see in this mixing set that this system is a OEM factory stereo head unit and the system is using 6 channel summed inputs. Channels 1, 3, and 5 are each using 1/3 of each of the 3 left (odd) inputs and channels 2, 4, and 6 are using 1/3 of each right (even) input. Channels 7 and 8 are subwoofer channels being used mono, so they get equal amounts of all left and right inputs.

Auto Calibration. When used with the optional M-AT1 microphone, the GUI can automatically calibrate the major tuning functions of equalization, signal delay, and phase. Leaving you nothing much to do but sit back and enjoy the music.



The auto-tuning function equalizes the signal to a standard sound curve used in audio competitions that compensates for the acoustic difficulties of the automotive environment to give you a realistic “live” sound that you experience with live music.

- 1. Channel** selection lets you pick the channels the auto-tuning system will calibrate.
- 2. Option** lets you choose to have the system calibrate all the parameters or only one.
- 3.** During the calibration run you can choose to see what the system is doing on the graph by looking at the **Speaker curve**, or the **Equalization curve**, and you can turn the visual **Target curve** on or off.
- 4.** After the calibration is done you can save it or cancel it. Why would you want to cancel? First, glitches can happen and if you see something odd in the graph you can cancel and start over. The bigger reason is noise. The microphone hears everything, so you’ll want to do the calibration runs in a quiet location. You neighbor’s lawn mower or an airplane overhead or any other noises will affect what the auto-tune does to the frequency response of the system.

5. The **Tips** area will display messages or reminders i.e. To make sure your crossovers are set before the calibration run (to protect the tweeters).

6. The **Start** button to begin Auto Calibration.

The Auto Calibration process

First, remember that the microphone will hear everything whether it is in the car or outside the car, so you need to have a quiet place to make the autotune that will remain quiet until the process is complete.

1. The M-AT1 microphone has been calibrated to give accurate response when used with the DSP-IV AT processors. However, the results you get can vary greatly with the position of the microphone. Basically, the auto-tune function will assume that you head is exactly where the mic is and it will tune the system for the optimum sound stage at that point by automatically adjusting signal delay. You can experiment with the mic to see what works best for your situation. You can also run the system just for the driver on one preset then run it with the mic at the passenger’s head position on another preset, and switch between them.

2. As above, you can run the system on all the channels at once or you can do them one at a time. For the first tune you should choose all the active channels and let the auto-tune set everything. Of course, no system is perfect, and every car is different. The first run will come close, but subsequent runs can bring you closer still to the target.

3. Choose the option (function) you want to auto-tune and again for the first run you should let the system set all three functions. On subsequent runs you can usually tune only equalization.

4. Press Start to begin the process. At this time the system will prompt you the make sure you have set crossovers for all the speakers. This is critical, not only for proper equalization, but the high-volume pink noise can destroy tweeters and other small drivers if they are not protected from the lower frequencies.

5. Leave the vehicle, close the door, and let the system work. You can view the process on the PC and it will let you know when the process is complete.

6. At that point you will be asked if you want to keep the information or delete it. If you keep it, all settings will be applied the to DSP and you can then save it to a preset.

The File Menu

Saving your work is critical. Whenever you have the PC connected to your DSP all the work you are currently doing is at risk of being lost if something should happen to cause a loss of power to the system or to close the GUI prematurely. So, like anything else in a computer, save and save often. Saving and Loading of files and presets is through the FILE menu in the upper left corner of the GUI (Point 1, Pag. 14).

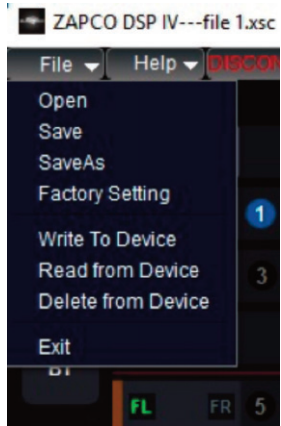

The file menu allows you to:

1. **Open** a file that has been stored on your computer.
2. **Save a file** that you want saved on the computer.
3. **Save As** lets you choose a location to save the file in**
4. **Factory Setting** will let you completely erase all current settings.
5. **Write to Device** puts the current settings into a DSP memory preset.
6. **Read from Device** loads a saved memory preset from the DSP.
7. **Delete from Device** allows you to delete one or more presets from the DSP.

** For saving files to the PC you should create a sub folder named DSP Settings. The first time you save a file you click Save As and navigate to your DSP Settings folder. Then highlight the system's file name, enter a name you create and click Save. Occasionally you may need to do this a couple of times but usually after the first time that you Save a file and Open a file those functions will automatically take you directly to the correct folder.

Write to Device will open the memory preset menu. There you can choose to save in any of 10 preset positions. Unused positions have a green background while the currently used presets have a red background. Click Select Save Place and choose a green position. If you select a red position, you will overwrite whatever is there with the new parameters. When you click Save you will be asked to give a name for the preset. You choose a name and click OK and the preset will be saved. You will see the save progress and then system will tell you the save was successful.



Read from Device works the same way. You will get the Read from Device menu and at the bottom you can Select Read Place, choosing any of the saved memory positions, and then click Read to load the settings of that memory preset into the DSP. Delete from Device opens a similar menu screen, and you choose the preset you no longer want and click Delete. The Delete menu will stay open so you can delete more than one preset if you wish. When finished you can click the X to close the menu.

Manual Setup without Auto Calibration

As explained earlier in reviewing the GUI, the process will start by choosing your input setup as 2-Ch, 4-Ch, etc. and summing channels, if needed, to get a full range signal from a factory head unit. Then you can name the channels and set the crossovers as per the recommendations of the speaker makers. You need to also measure the distance from the listening position to each speaker center as accurately as you can and let the GUI calculate the delay for each speaker.

Begin phase check: R/L Balance in the middle

A. Tweeters: Click to Mute all channels except the tweeters. Note that tweeters are the most difficult to phase. They are the smallest drivers and are not loud. You need complete quiet. Play a music track of female vocal and notice where the vocal originates (you may need to lower the crossover point for this. If so, keep the volume low and you may want to use a 48 dB slope, so you do not blow tweeters. We have already set the calculated delay, so the vocal should come from a specific location near the center of the windshield. If the tweeters are not correctly in-phase, then the sound will not have a specific location. It will splash and seem to come from everywhere at the same time. You will not be able to locate the sound at a specific spot. To the left of the Delay bars you see the Phase buttons. All should say 0 at this point. Click the Right channel tweeter to 180 and listen for the difference. Do this a few times and you will see that in one position the vocal is easily located near the center of the window while in the other it seems to come from everywhere and cannot be located. Obviously, you want the right speaker to be in the polarity that puts it in phase with the left, so the image is centered in the middle of the dash. Note: Once you establish the proper phase combination of a pair of speakers, it never changes. You do not change one without changing the other as they are now a matched pair. If you have changed the crossovers of the tweeters for phase check, you can put them back to normal now.

B. Midrange and Woofer/Mid-Bass: Now mute all but the midrange. These are easier because phase is more obvious at lower frequencies and because you can use more volume. The procedure is the same but now you should use the male vocal. Listen for the vocal location. It should be at a specific location near the center of the window. Change the phase of the right speaker a few times and listen to the difference. Use the combination that puts the vocal in a specific central location. Then you can mute all but the Mid-Bass and do the same as for the midrange. Note: Another easily heard sign of phase in mids and woofers is bass. When 2 speakers are out of phase there will be less bass. More bass in-phase/less bass out-of-phase, listen for this in addition to the localization.

C. Subwoofers: Woofers are the easiest. Play something with bass. The male vocal should work fine. If you are using multiple woofers they must be in phase or your bass will go away. When you change the phase of the right woofer it will be extremely obvious which polarity is correct. Note: Now you have phased each pair of speakers. Hopefully all are still 0, but if not it's OK, but from now on they can only be changed by the pair. Never change only one driver out of a pair. It's best to make a chart of speaker phases so you have it for reference later.

Phasing the System: Setting the front stage

D. Tweeters to Mids: Now we start phasing the driver pairs to get a proper front stage. Again, from here on we change only by the pair. Mute all except the tweeter and midrange channels and listen to a musical track. The main vocal should be centered and the sound stage should be spread across the window about 1/2 ~ 2/3 the way up. Listen for this. Now change the phase of both midranges and see where the sound stage is. If the tweeters and mids are out of phase, the stage will be lost (usually it will drop toward the floor). Do this a few times (always changing only the mids) and see which position puts the sound stage higher up where it should be, right across the window. You will leave these this way now and bring in the Mid-Bass.

E. Woofers/Mid-Bass: Un-mute the mid-bass and see where the sound stage goes. If it pulls down to toward floor, then reverse the phase of the mid-bass drivers. Try both ways a few times to see which gives the correct sound stage.

F. Subwoofers: Subs can be difficult, but not because of bass. You have already phased the woofers. There will be bass! The issue will be the transition from bass to mid-bass. Play a cut with good mid-bass (kick drums are excellent). Look for sharp solid mid-bass. Change the phase of the subs a couple of time and listen. A bad transition will leave mid-bass soft and weak. Also listen for location. you want the bass to be in the sound stage... not in the trunk. If your woofers are in a portable enclosure you may even want to move the box location to see what that does. The key is finding that combination that gives clean solid mid-bass that seems to come from the front of the car.

Now you have set the R-to-L phase of each pair of speakers and you have blended each pair into the system in the correct phase for the best sound stage.

SAVE: At this point you completed the system setup and will want to Save to File then Write to Device to save the work. Write to 2 memory positions so you have one to work on and one as reference.

Manual Tuning

At this point you have effectively set up your entire system. Each channel has the correct input, each speaker has been identified as to function, the crossovers have been set for each speaker, the delays are set for the proper sound stage and you have assured that all speakers are operating in the same polarity acoustically. Now it is time for the most difficult and most subjective part. Tuning the system to have the correct sound in the car. Since every car is different from every other car, the tuning must be done specifically for your individual car and your specific equipment. A car is a poor listening environment because so many factors in the car change the sound as it moves through the car interior. Windows, upholstery, even the very shape of the car all affect the sound waves and you need to tune the system to compensate for those affects.

The goal is to get the sound the artist intended, even though you are sitting in your seat in the car, and not at a concert. To do the tuning you will need a 1/3 Octave RTA (Real Time Analyzer) and a source of "pink noise". Pink noise is sound that has equal signal levels at all octaves. It is a standard of reference that, in conjunction with an RTA can show you what your car is doing to the frequency response. Then you can compensate with the equalizer. Also handy is a 31 column sheet to chart the response before equalization.

The Tuning Tools of the GUI

You will use the EQ graph and the Function bar above for making the EQ adjustments. Below we lay out the EQ tuning functions.

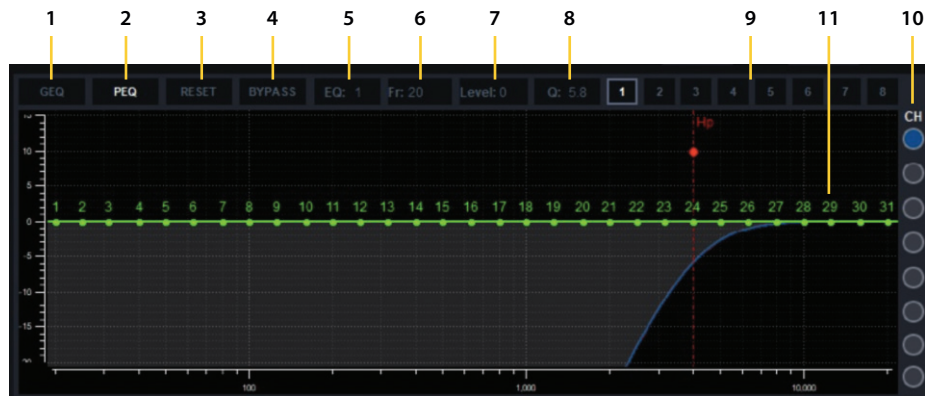

1. GEQ: There are two types of Equalizers in the DSP-Z8 IV AT GUI. The early EQs were Graphic EQs. Each band had an assigned frequency and an assigned Q factor. Q determines the shape to the filter. A low Q gives a wide adjustment and a high Q gives a narrow sharper adjustment. In most early EQs your only adjust was the level of boost or cut that was made with the filter band while some had adjustable Q.

2. PEQ: More popular today is the Parametric Equalizer or PEQ. The parametric EQ allows you to put the filter at any frequency that needs attention, so any filter can be at any frequency. It also allows you to determine the Q of the filter, so you can boost or cut a large group of frequencies, or you can pinpoint only a few frequencies to be affected. By watching the RTA while you are making adjustments you will see how wide or narrow the adjustment needs to be and you can adjust the Q accordingly.

3. Reset: Occasionally you may decide you don't like what you've done to a channel. The reset button allows you to reset all the filters of a channel to 0 dB.

4. Bypass: The bypass button lets you temporarily bypass the EQ of a channel to hear the channel with and without equalization for A/B comparisons.

5. EQ: This is the EQ band box. You can choose which of the 31 EQ bands you will adjust by clicking on any of the green band buttons and using drag-n-drop, but you can also click into the EQ band box and type in a band number or use the up/down arrows of the keyboard to scroll through the bands.

6. Fr: Similarly, the Fr: box lets you change the frequency of a band. If you have made an adjustment and the frequency is not quite right, you can click into the Fr: box and move the center frequency up or down with the up/down arrows.

7. Level: As we said before, you can drag-n-drop a band button to make EQ adjustments, but they will be rough adjustments. If you click into the Level box, you can make fine adjustments .5 dB at a time using the keyboard arrows.

8. Q: Clicking into the Q box lets you change the shape of the filter using the keyboard arrows. While watching the RTA you can see exactly what your changes are doing to the acoustic response as you make the fine adjustments.

9. EQ Link buttons: The first Equalization should always be done by R/L channel pairs. To do this you use the EQ Link buttons. Example: Click Ch1 in the CH OUTPUTS column to open Ch1. The Ch1 button 1 will be highlighted and the Ch1 row will be bright. Now you can click 2 and Ch2 will become bright as well to let you know that Ch1 and Ch2 are linked. The next time you click any channel in the CH OUTPUTS column the link will be broken. Notes: a. You should only link 2 channels at a time b. After the first equalization you can modify one channel or the other and then re-link them for further adjustment, but this should only be done by experienced tuners. 99% of all installation will have the best results by paired channel equalization c. It is possible to link all the channels except the Subs. The subs can only be linked to each other. This linking again however should only be used by experienced tuners.

10. Trace buttons: You will always see the EQ and Crossover traces of the active channel being worked on. The color-coded buttons at the left allow you to include other traces in the graph so you can see how they interact.

11. The EQ graph will always show all the available bands for the active channel as the green band buttons. Before any adjustments they are all on the 0 dB. After adjustment the buttons will be in their position on the response curve (the trace) you have set with your adjustments.

What We Want to Achieve

You will use the EQ graph and the Function bar above for making the EQ adjustments. Below we lay out the EQ tuning functions. Of course, there is no way to know what the response in any particular car will be. However, we can say what response we want to achieve. The first step is to play pink noise through the system and read the output level of each 1/3 octave band on the RTA. For tuning, you will want to have your system playing a slightly loud volume. With pink noise playing you should turn the system up so the response curve centers around 90dB. Your RTA will tell you the volume level in dB. Chart them each for dB level so you know how much you need to add or subtract much to make to bring them all close to the shape you want. Note that as much as possible you want to subtract with the EQ and not add, as adding gain with the equalizer can cause more stress on your amps and can add noise to the system. Then you need to decide what curve you want to have. Here are a few samples. Remember that these curves are what we want to see on the RTA. Your EQ graph will look far different.

Flat Response Curve

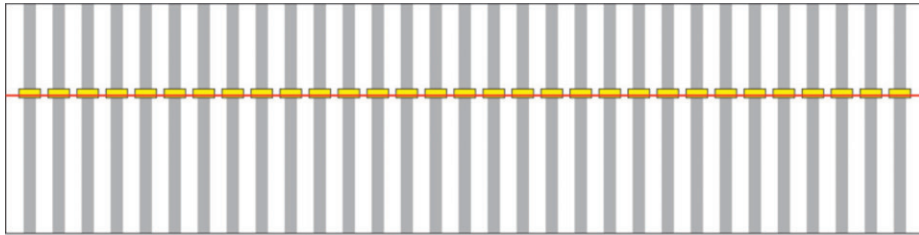

Many people try this first. a. It is very difficult b. It will almost always sound bad. It will be lacking in bass and sound harsh on the high end. How the ear works at different frequencies and volume levels affects what response will sound best.

Best Response Curve

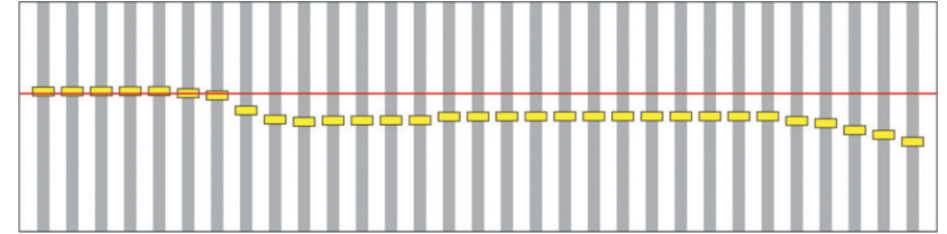

The best curve will be higher in the bass frequencies and will have only small changes from each 1/3 octave band to the next, then it will roll off at the higher frequencies.

A Good Response Curve

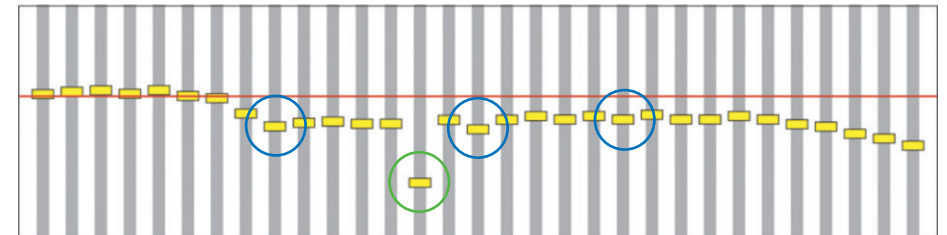

This is actually a good Frequency curve. There are some small out-of-line variations (Blue circles) but they are small and you won't hear them. There is one big variation (green circle) which is the single low point, or null point. This can be caused by a phase issue (usually around a crossover). You should not try to equalize out a null point because, a) your ear is not very sensitive to drop-outs so you likely won't notice it at all, and b) trying to equalize it will only waste power and will likely distort the frequencies on either side of it. While it is best not to try to equalize a null point, you will want to check your crossovers. If you have a null point directly at the crossover between 2 drivers you may have a crossover spaced too far apart. But if the crossovers are OK then leave as is.

A Bad Response Curve

At the bottom line the sound you want from your car will be subject to your tastes. Everyone will like the “Best Response Curve” and everyone will like the “Good Response Curve”. They may not be exactly what some want, but they will sound good and they will be comfortable to listen to. The reason is that there are no peaks in the response. The ear is very sensitive to frequency peaks, and they irritate the listeners ears. This irritation causes “listener fatigue” and after a while the listener will want to turn the system down... or even off.

#1 and #2 Tuning issue

So, the number one goal in tuning is always to eliminate frequency peaks, and number 2 is always cut, don't boost. Boosting frequencies requires more amplifier power, increases the likelihood of distortion and causes increased noise. If you have diligently read this manual you now have a starting point to get the exact sound you want from your sound system in your vehicle. Tuning a sound system is a growth project. The more you tune and the more you listen, the better you will get. If you want to grow in your tuning ability the best thing you can do is go to car audio contests and listen to every car you can with music you are familiar with so you can compare those cars to your car. And make notes about what you liked as a reference for the next time you listen to your own system. For a few dollars you can enter the contests to get your car on the show floor. The guys at these shows are car audio fanatics and they want to spread the word. They will be more that glad to hop into your car and listen. And tell you what you can do to improve your system. This the very best source you will find to learn how you can improve your tune.

Technical Specifications

	DSP-Z8 IV AT	DSP-Z16 IV
Type	8-Ch. DSP	16-Ch. DSP
DSP Processor	Cirrus Logic CS47048 32-bit/192 KHz, 108 dB DR THD+N -98 dB	Cirrus Logic CS47048 32-bit/192 KHz, 108 dB DR THD+N -98 dB
AD Signal Converter	Cirrus Logic CS47048 32-bit/192 KHz, 108 dB DR THD+N -98 dB	Cirrus Logic CS47048 32-bit/192 KHz, 108 dB DR THD+N -98 dB
DA Signal Converter	Cirrus Logic CS8422 24-bit/192 KHz, 140 dB DR THD+N -120 dB	Cirrus Logic CS8422 24-bit/192 KHz, 140 dB DR THD+N -120 dB
Hi-Level Speaker Inputs	8 Ch., 2-20 V	12 Ch., 2-20 V
RCA Inputs	8 Ch., 1-5 V RMS	8 Ch., 1-5 V RMS
RCA Outputs	8 Ch., 1-5 V RMS	16 Ch., 1-5 V RMS
Optical Digital Input	24-bit/192 KHz	24-bit/192 KHz
Coaxial Digital Input	32-bit/192 KHz	32-bit/192 KHz
Signal Stage	Freq. Response: 10 Hz - 22.5 KHz S/N In: 110 dBA (D), 106 dBA (A) THD+N In: 0,002% (D), 0,005% (A) - Crosstalk (1 KHz): 90 dB -	Freq. Response: 10 Hz - 22.5 KHz S/N In: 110 dBA (D), 106 dBA (A) THD+N In: 0,002% (D), 0,005% (A) - Crosstalk (1 KHz): 90 dB -
Equalizer	1-6 Ch. Gr. & Par. / 31 poles (F/R) 7-8 Ch. Gr. & Par. / 11 poles (Eff.)	Graphic / Parametric 31-Bands
Delay/Polarity	Range 0/15 ms, Step 0.02 ms Max 515 cm, Step 0.68 cm Polarity 0-180°	Range 0/15 ms, Step 0.02 ms Max 515 cm, Step 0.68 cm Polarity 0-180°
Mute/Solo	Yes, each channel	Yes, each channel
Crossover Type	Linkw., Butterw., Bessel, Tseheb.	Linkw., Butterw., Bessel, Tseheb.
RMS Power	- -	- -
PC Connection	USB 2.0	USB 2.0
BT Streaming	aptX HD (optinal ext. module)	aptX HD (optinal ext. module)
Remote Control	1" LCD Prev/Next/Mode/Source/Vol	1" LCD Prev/Next/Mode/Source/Vol
Size (mm)	213 (W) x 113 (L) x 50 (H)	213 (W) x N/A (L) x 50 (H)

Technical Specifications

	ADSP-Z8 IV-6AT	ADSP-Z12 IV-10A
Type	8-Ch. DSP + 6 Ch. Amp.	12-Ch. DSP + 10 Ch. Amp.
DSP Processor	Cirrus Logic CS47048 32-bit/192 KHz, 108 dB DR THD+N -98 dB	Cirrus Logic CS47048 32-bit/192 KHz, 108 dB DR THD+N -98 dB
AD Signal Converter	Cirrus Logic CS47048 32-bit/192 KHz, 108 dB DR THD+N -98 dB	Cirrus Logic CS47048 32-bit/192 KHz, 108 dB DR THD+N -98 dB
DA Signal Converter	Cirrus Logic CS8422 24-bit/192 KHz, 140 dB DR THD+N -120 dB	Cirrus Logic CS8422 24-bit/192 KHz, 140 dB DR THD+N -120 dB
Hi-Level Speaker Inputs	8 Ch., 2-20 V	8 Ch., 2-20 V
RCA Inputs	8 Ch., 1-5 V RMS	8 Ch., 1-5 V RMS
RCA Outputs	2 Ch., 1-5 V RMS	2 Ch., 1-5 V RMS
Optical Digital Input	24-bit/192 KHz	24-bit/192 KHz
Coaxial Digital Input	32-bit/192 KHz	32-bit/192 KHz
Signal Stage	Freq. Response: 10 Hz - 22.5 KHz S/N In: 110 dBA (D)106 dBA (A) THD+N In: 0,002% (D), 0,005% (A) THD+N Analog In: 0,07% (DSP+Amp) Crosstalk (1 KHz): 90 dB Crosstalk: 45 dB (DSP+Amp)	Freq. Response: 10 Hz - 22.5 KHz S/N In: 110 dBA (D)106 dBA (A) THD+N In: 0,002% (D), 0,005% (A) THD+N Analog In: 0,07% (DSP+Amp) Crosstalk (1 KHz): 90 dB Crosstalk: 45 dB (DSP+Amp)
Equalizer	Graphic / Parametric 31-Bands	Graphic / Parametric 31-Bands
Delay/Polarity	Range 0/15 ms, Step 0.02 ms Max 515 cm, Step 0.68 cm Polarity 0-180°	Range 0/15 ms, Step 0.02 ms Max 515 cm, Step 0.68 cm Polarity 0-180°
Mute/Solo	Yes, each channel	Yes, each channel
Crossover Type	Linkw., Butterw., Bessel, Tsecheb.	Linkw., Butterw., Bessel, Tsecheb.
RMS Power	6 x 80 (4Ω), 6 x 120 (2Ω) 3 x 240 Watt (4Ω/Bridged)	10 x 80 (4Ω), 10 x 120 (2Ω) 5 x 240 Watt (4Ω/Bridged)
PC Connection	USB 2.0	USB 2.0
BT Streaming	aptX HD (optinal ext. module)	aptX HD (optinal ext. module)
Remote Control	1"LCD Prev/Next/Mode/Source/Vol	1"LCD Prev/Next/Mode/Source/Vol
Size (mm)	213 (W) x 222 (L) x 50 (H)	213 (W) x 291 (L) x 50 (H)

	ADSP-Z16 IV-12A
Type	16-Ch. DSP + 12 Ch. Amp.
DSP Processor	Cirrus Logic CS47048 32-bit/192 KHz, 108 dB DR THD+N -98 dB
AD Signal Converter	Cirrus Logic CS47048 32-bit/192 KHz, 108 dB DR THD+N -98 dB
DA Signal Converter	Cirrus Logic CS8422 24-bit/192 KHz, 140 dB DR THD+N -120 dB
Hi-Level Speaker Inputs	12 Ch., 2-20 V
RCA Inputs	8 Ch., 1-5 V RMS
RCA Outputs	4 Ch., 1-5 V RMS
Optical Digital Input	24-bit/192 KHz
Coaxial Digital Input	32-bit/192 KHz
Signal Stage	Freq. Response: 10 Hz - 22.5 KHz S/N In: 110 dBA (D)106 dBA (A) THD+N In: 0,002% (D), 0,005% (A) THD+N Analog In: 0,07% (DSP+Amp) Crosstalk (1 KHz): 90 dB Crosstalk: 45 dB (DSP+Amp)
Equalizer	Graphic / Parametric 31-Bands
Delay/Polarity	Range 0/15 ms, Step 0.02 ms Max 515 cm, Step 0.68 cm Polarity 0-180°
Mute/Solo	Yes, each channel
Crossover Type	Linkw., Butterw., Bessel, Tsecheb.
RMS Power	12 x 80 (4Ω), 12 x 120 (2Ω) 6 x 240 Watt (4Ω/Bridged)
PC Connection	USB 2.0
BT Streaming	aptX HD (optinal ext. module)
Remote Control	1"LCD Prev/Next/Mode/Source/Vol
Size (mm)	213 (W) x 291 (L) x 50 (H)

Software/PC requirements:
Microsoft Windows (32/64bit): XP, Vista, Windows 7, Windows 8, Windows 10. Continuous exposure to excessive sound pressure levels may cause permanent hearing loss. ZAPCO strongly advises that you use common sense when setting volume levels. Everything written in this manual is for the proper use of the products. Some features or specifications could be modified during production to improve the product performance. The technical specifications and functionalities stated here are current as of the time of publication. General instructions and safety warnings are intended in any case to be always effective for this type of product. The latest manual with any updates is always available at:
www.zapco.com/download



Modesto, California USA
Since 1974

zapco.com