



ES	<b>Instrucción de montaje</b> ¡Leer primero!	Kit fijación
EN	<b>Assembly instructions</b> Read first!	Fixation Kit
FR	<b>Instruction de montage</b> Lire en premier!	Kit fixation
DE	<b>Montageanleitung</b> Zuerst lesen!	Stützfuß-Kit
PT	<b>Instruções de montagem</b> Ler primeiro!	Kit fixação
IT	<b>Istruzioni di montaggio</b> Leggere per primo!	Kit di fissaggio
NL	<b>Montagehandleiding</b> Eerst lezen!	Bevestigingsset
PL	<b>Instrukcja montażu</b> Najpierw przeczytaj!	Element mocujący
CZ	<b>Montážní návod</b> Čtěte pozorně!	Fixační kit
HU	<b>Szerelési Utasítás</b> Először olvassd el!	Rögzítő készlet
HR	<b>Detaljne upute</b> Prvo procitaj!	Kit za montažu
RO	<b>Instructiuni de montaj</b> Intai cititi!	Kit de fixare
RU	<b>Инструкции по монтажу</b> Сначала прочитайте!	Крепежный комплект
GR	<b>Διαβάστε προσεκτικά τις</b> Οδηγίες Συναρμολόγησης!	Κιβώτιο (Kit) Επισκευής
TR	<b>Öncelikle montaj:</b> Talimatlarını okuyunuz!	Montaj kiti
SI	<b>Navodila za sestavljanje</b> Preberite!	Kit za pričvrstitev

# 935-958

Lv7 2024-r1

Modelo-model:

## Kit CRUZ Optiplus

Lote-Lot-Lot-Lot:

**01-24**

Peso-Weight-Poids-Gewicht:

**0,95 kg / 2,09 lbs**



Kit tipo (Certificación)  
Kit type (Certification)  
Kit type (Certificat)  
Kit Typ (Zertifizierung)

**B**

CEE - EEC type approval:



26 R- 04 3015

CRUZBER SAU  
ES-A14018311  
P.I. Las Salinas II  
14960 - Rute - Spain  
cruz-products.com



1.



x1



x1



(018-041)

x1



(810-045)

x4



1x (3886)  
1x (3887)  
1x (3888)  
1x (3889)

x4



(012-080)

x4

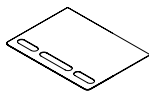

(018-098)



**Importante!**  
**Important!**  
**Important!**  
**Wichtig!**

IT Questo kit di fissaggio deve essere usato con i portapacchi CRUZ

RO Acest Kit de fixare, trebuie utilizat cu sisteme CRUZ!

ES ¡Este Kit de fijación tiene que usarse con sistemas portacargas CRUZ!

NL Deze bevestigingsset moet worden gebruikt in combinatie met CRUZ dakdrager systeem!

RU Крепежный комплект должен быть использован с багажной системой на крышу марки CRUZ!

EN This fixation Kit must be used with CRUZ roof rack systems!

PL Niniejszy element mocujący musi być używany z systemami bagażników dachowych firmy CRUZ!

GR Το αξεσουάρ αυτό θα πρέπει να χρησιμοποιείται αποκλειστικά στα συστήματα μπαρών της CRUZ!

FR Cet Kit de fixation devra être utilisé avec les systèmes porte-charge CRUZ!

CZ Tento fixační kit musí být používán s nosným systémem CRUZ!

TR Bu aksesuar mutlaka CRUZ taşıma sistemleriyle kullanılmalıdır!

DE Dieser Stützfuß-Kit muß mit CRUZ Dachträgersystemen benutzt werden!

HU Ez a rögzítő készlet csak a CRUZ rendszerekkel használható!

SI Kit za pričvrstitev naj se uporablja le z izdelki iz asortimana strešnih košar CRUZ!

PT Este Kit de fixação deve ser utilizado com os sistemas porta cargas CRUZ!

HR Kit za montažu mora biti korišten uz CRUZ sistem krovnog nosača!

## 2.

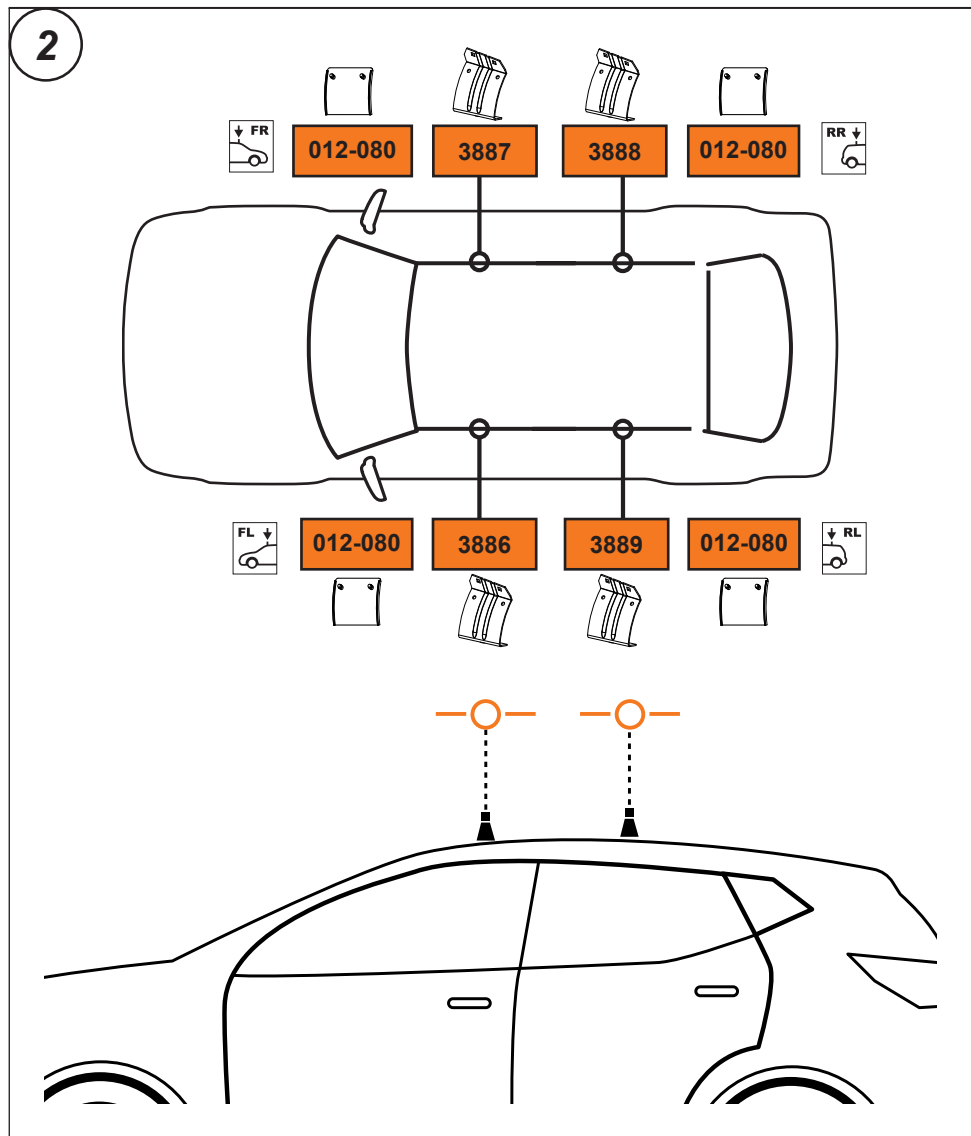
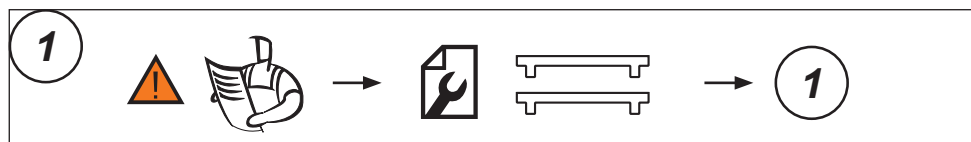

3. 

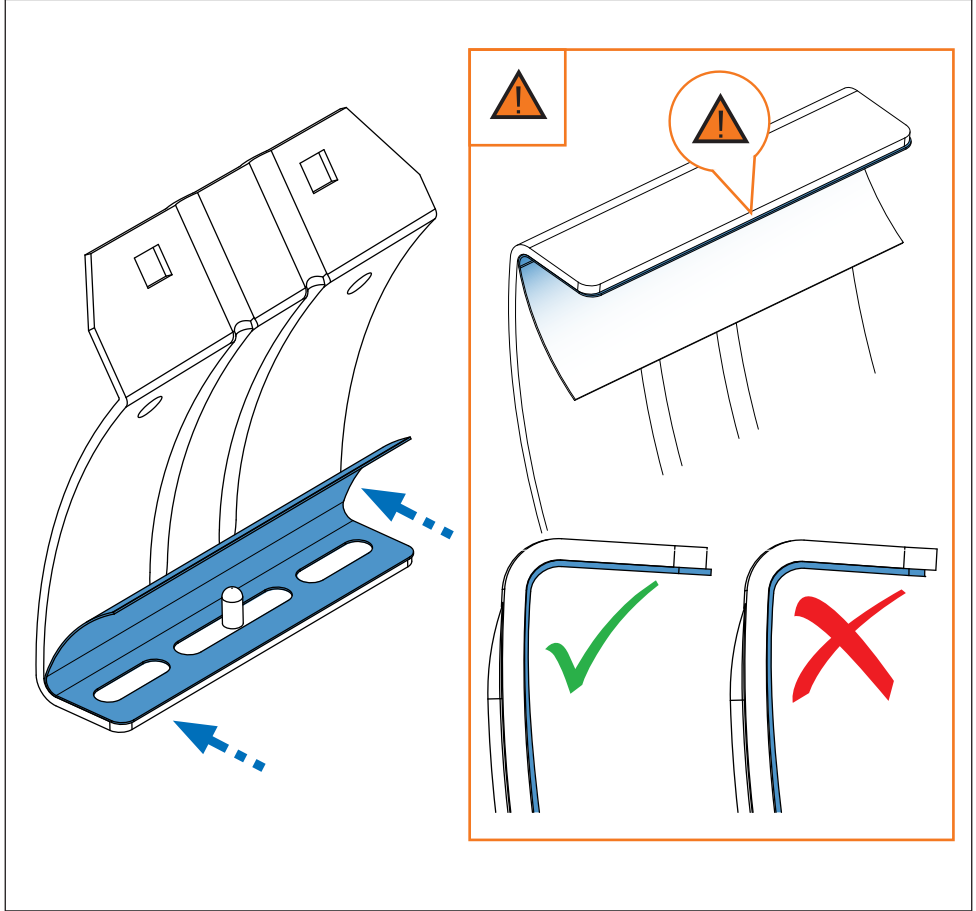
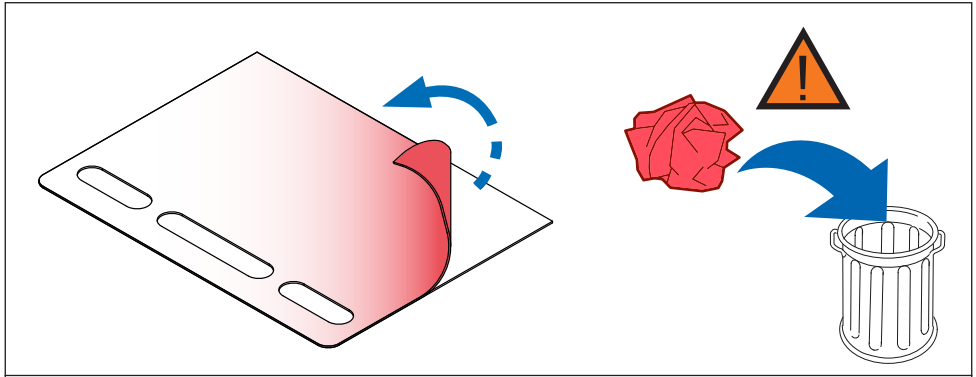

4. 

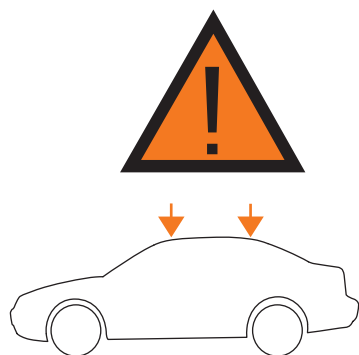

5. 

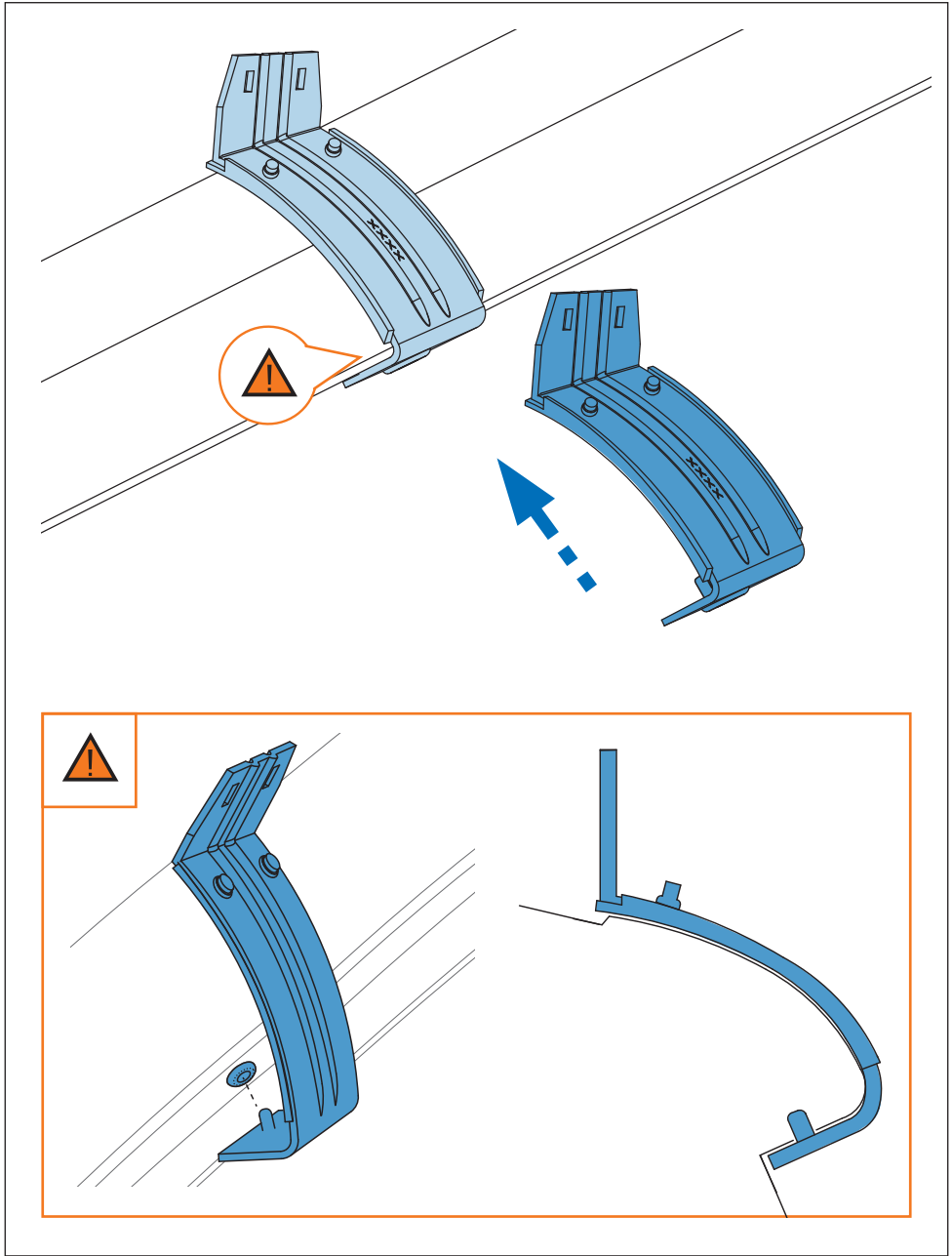

6. 

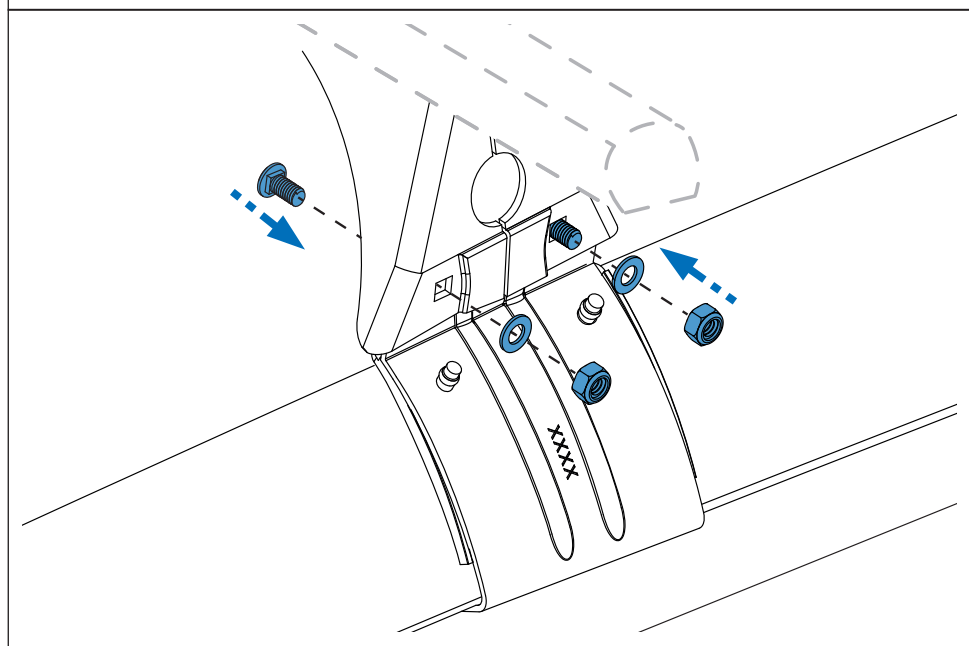
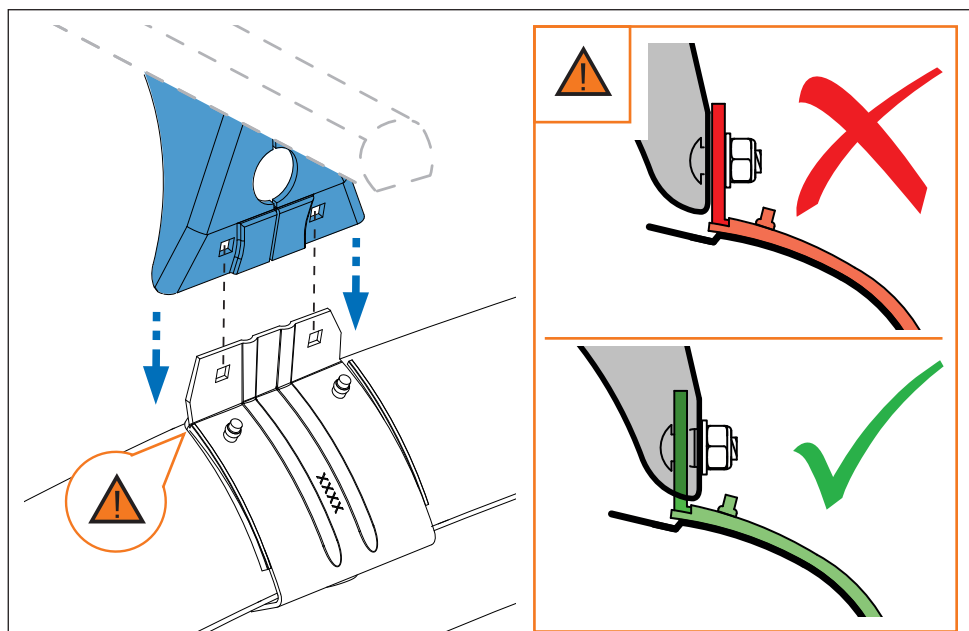

7. 

