



924-09x

Lv7 2018-r9

Modelo-model:

Alu Cargo AF

Lote-Lot-Lot-Lot:



Peso-Weight-Poids-Gewicht:

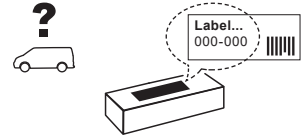

Max. 100 kg

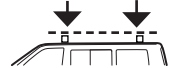

Código Homologación CEE
EEC Type Approval Number

E9 26 R- 03 3022



CITY CRASH (✓)
Accor ding to ISO/ P. AS 11154:2006

CRUZBER SA
ES-A14018311
P.I. Las Salinas II
14960 - Rute - Spain
www.cruzber.com

E Instrucción de montaje
¡Leer primero!

GB Assembly instructions
Read first!

F Instruction de montage
Lire en premier!

D Montageanleitung
Zuerst lesen!

PT Instruções de montagem
Ler primeiro!

PL Instrukcja montażu
Najpierw przeczytaj!

CZ Montážní návod
Čtěte pozorně!

HU Szerelési Utasítás
Először olvasd el!

RO Instrucțiuni de montaj
Intai cititi!

HR Detaljne upute
Prvo pročitati!

GR Διαβάστε προσεκτικά τις
Οδηγίες Συναρμολόγησης!

TR Öncelikli montaj:
Talimatlarını okuyunuz!

RU Инструкции по монтажу
Сначала прочитайте!

I Istruzioni di montaggio
Leggere per primo!

NL Montagehandleiding
Eerst lezen!

SLO Navodila za sestavljanje
Preberite!

Barras de aluminio

Aluminium bars

Barres d'aluminium

Aluminiumdachträger

Barras d'alumínio

Belki aluminiowe

Hliníková sada tyčí

Aluminium rudak

Aluminijske šipke

Bare din aluminiu

Μπάρες Αλουμινίου

Alüminyum barlar

Алюминиевые
поперечины

Barre di alluminio

Aluminium dakdragers

Aluminijske prečke



1.



(E) Contenido embalaje: ¡Verificar!

x1

x1

(GB) Package content: Check!



(F) Contenu d'emballage: Vérifier!

(D) Packungsinhalt: Überprüfen!

x2

(PT) Conteúdo embalagem:
Verificar!

(PL) Zawartość opakowania:
sprawdź!

(CZ) Obsah balení: Zkontrolujte!

(HU) Csomag tartalma: Ellenőrizd!

(RO) Pachetul contine: Verificati!

(HR) Sadržaj paketa: Provjeri!

(GR) Ελέγξτε το περιεχόμενο του
πακέτου!

(TR) Paket içeriğini: Control ediniz!



(RU) Содержание упаковки:
Проверьте!

(I) Contenuto della confezione:
Controllare!

(NL) Pakket inhoud: Controleer!

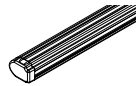
(SLO) Vsebina paketa: Preverite!

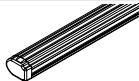

Código Code		\longleftrightarrow			Lote Lot
924-071	AF 118 (824-062)	118 cm	2x (012-151) 1x (012-152)	3,22 kg	01/18
924-090	AF 128 (824-064)	128 cm		3,74 kg	03/15
924-091	AF 138 (824-069)	138 cm		3,93 kg	03/15
924-092	AF 148 (824-074)	148 cm		4,11 kg	03/15
924-093	AF 158 (824-079)	158 cm		4,30 kg	03/15
924-094	AF 175 (824-084)	175 cm		5,00 kg	03/15

2.



**Importante!
Important!
Important!
Wichtig!**

- E** Estas barras tienen que usarse con Kits de fijación Cruz!
- GB** Bars must be used with Cruz fixation Kits!
- F** Les barres devront être utilisées avec les Kits de fixation Cruz!
- D** Die Dachlsträger nur mit Cruz Stützfuß-Kits befestigen!
- PT** As barras devem ser utilizadas com os Kits de fixação Cruz!
- PL** Belki muszą być stosowane z elementów mocującymi firmy Cruz!
- CZ** Tento nosič musí být používán s fixačním kitem Cruz!
- HU** A rudakat csak Cruz rögzítő készlettel szabad használni!
- RO** Barele trebuie utilizate cu Kit-uri de fixare Cruz!
- HR** Šipke moraju biti korištene sa Cruz kitovima za montažu!
- GR** Το αξεσουάρ αυτό θα πρέπει να χρησιμοποιείται αποκλειστικά στα συστήματα μπαρών της Cruz!
- TR** Bu barlar mutlaka Cruz montaj kiti!
- RU** Поперечины должны быть использованы со специальным крепежным комплектом Cruz!
- IT** Questa bare deve essere utilizzato solo con il kit di fissaggio Cruz!
- NL** Dakdragers moeten worden gebruikt in combinatie met de bevestigingssets van Cruz!

1

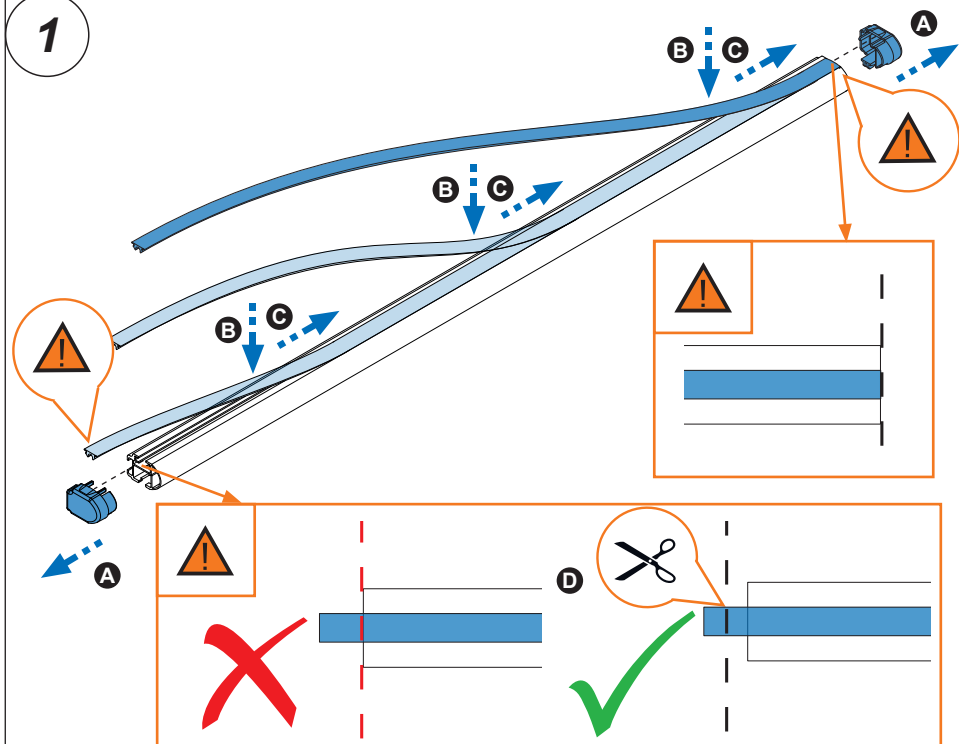

3. 

2

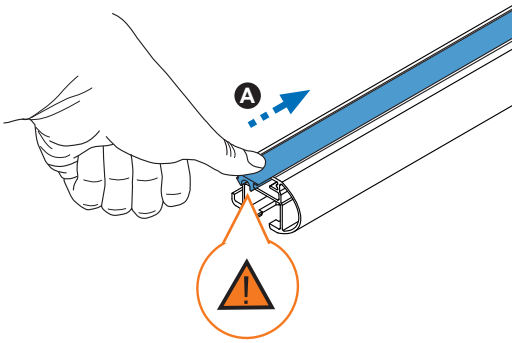





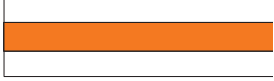



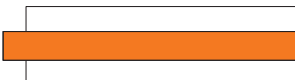

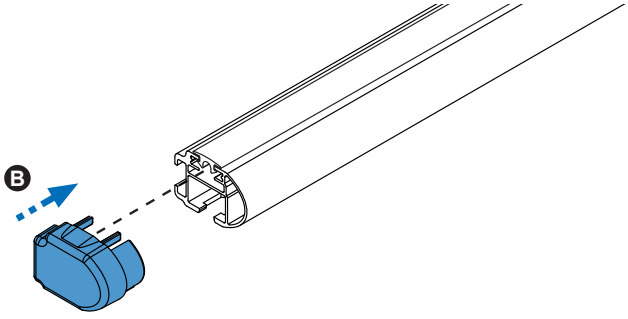



3

  → 